

# MEDITERRANEAN OBJECTS

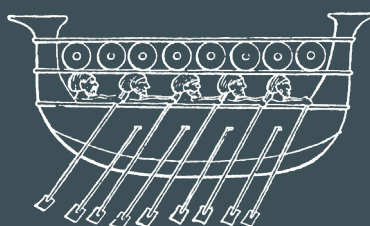

2024 LIGHTING CATALOGUE

Designed and produced in Barcelona

---

CATALOGO ILUMINACIÓN 2024

Diseñadas y producidas en Barcelona



[www.mtobjects.com](http://www.mtobjects.com)



## MEDITERRANEAN OBJECTS

Lamps designed and produced by hand in Barcelona.  
Handmade and with natural materials.

Mediterranean Objects  
It is elegance in art,  
It is luxury in craftsmanship,  
It is precision in simplicity,  
It is harmony in warmth.

---

Lámparas diseñadas y producidas a mano en Barcelona.  
Hechas a mano y con materiales naturales.

Mediterranean Objects  
Es elegancia en el arte,  
Es lujo en la artesanía,  
Es precisión en la sencillez,  
Es armonía en la calidez.



## THE ESSENCE OF THINGS

*Our mission is to be creators of beautiful and delicate objects that people love to have with them because of how good our warm essence makes them feel, thus improving the environment and people's quality of life.*

*The aim of our creations is to highlight that spiritual component, which is the essence of things.*

*We want people to feel love in the space they inhabit thanks to see our objects full of love, to feel identified with their own nature.*

*Each lamp represents that bright light that we all have inside; we want to help people remember the inner child that we were, are and will be as long as we turn on the inner light.*

## LA ESENCIA DE LAS COSAS

*Nuestra misión es ser creadores de objetos bellos y delicados, que las personas amen tener consigo gracias a lo bien que les hace sentir nuestra cálida esencia, mejorando así el entorno y la calidad de vida de las personas.*

*El objetivo de nuestras creaciones es resaltar ese componente espiritual, que es la esencia de las cosas.*

*Queremos que las personas sientan amor en el espacio que habitan gracias a ver nuestros objetos llenos de amor, que se sientan identificados con su propia naturaleza.*

*Cada lámpara representa esa luz brillante que todos tenemos dentro; queremos ayudar a recordar el niño interior que fuimos, somos y seremos siempre que prendamos la luz interior.*





BARRA TUBO →  
 BARRA PULIDA  
 HOMBRA (E HACE EN EL MISMO METAL O UNA BARRA ESPECIAL).  
 DISCO ↓  
 tubo lino  
 mecanizado p/ tornillo  
 no es latón, lijado - barniz - barniz, es latón, pulido.  
 INECO O HERRERA  
 INECO EN LAZOS  
 3 (PRELIMINAR)  
 PIEZA EMBUDO/CONE  
 INECO H/ TORNILLO BASE  
 TORNILLO CABEZA GÁLICA.

- 1º Corte barra
- 2º Mecanizado base hombre + Pegar hombre.
- 3º Si no es latón, lijado - barniz - barniz. Si es latón, pulido.

TALLADO P/ MANO  
 MONTANTE MADERA  
 TALLADO P/ SALIDA CABLE.  
 TALLADO APROX 30 CM PARA PASO VACILLA ROSCADA.

- 1º Corte barra
- 2º Tallados x 3.
- 3º Pegar base
- 4º barnizado.

SOLUCIONA BASTANTE... 2m / tubo  
 1m / pie.

1º Corte barra  
 2º Mecanizado base p/ tornillo tubo p/ cable superior p/ hombre. + Pegar hombre.  
 3º Si no es latón, lijado - barniz - barniz. Si es latón, pulido.

DESIGN

posible otras más finas posibles.

(TALLADO DE 30A PARA USO TOTAL)

LATÓN

Corte barra + TALLADO + BARNIZADO  
 4 y 5, TALLADO LATERAL

x NEGRO = BARRA  
 x BLANCO





**MANUFACTURING**





**Pendant lamps /  
Lámparas suspendidas**

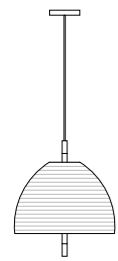

*Amà*  
p. 14

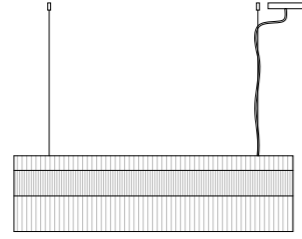

*Suau Large Series*  
p. 36

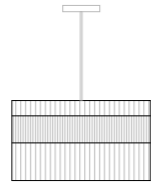

*Suau XL*  
p. 40

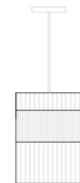

*Suau M*  
p. 42



*Suau cone*  
p. 44

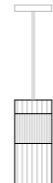

*Suau slim*  
p. 44

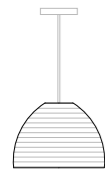

*Costa dome*  
p. 60



*Costa cylinder*  
p. 60



*Costa cone*  
p. 60

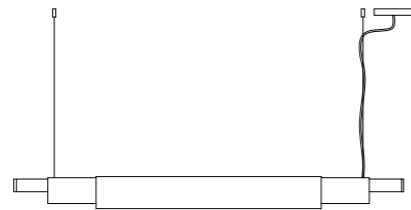

*Vol pendant*  
p. 64

**Wall lamps /  
Apliques de pared**

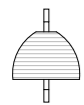

*Amà*  
p. 18

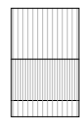

*Suau R*  
p. 46



*Suau S*  
p. 48



*Costa cylindrical*  
p. 52



*Costa cone*  
p. 54



*Costa shell*  
p. 56



*Costa mini*  
p. 58

**Table lamps /  
Lámparas de sobremesa**



*Amà*  
p. 22

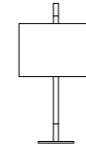

*Amà fabric*  
p. 26

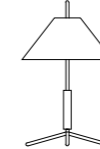

*Vol table series*  
p. 68

**Floor lamps /  
Lámparas de pie**



*Amà*  
p. 28



*Suau*  
p. 50





# AMÀ

## LAMP COLLECTION

2021  
Designed by Mariano Chitarrini

*Amà, comes from the Catalan "a mà", which means "handmade", and it is how this lamp is made. With hand-turned beech wood, solid brass details, and hand-woven lampshade, in natural rattan.*

*Mediterranean, simple, elegant.*

*Designed by Mariano Chitarrini in Barcelona, and inspired by the atmospheres of Mediterranean houses, by the great architects of the 20th century.*

*It is a tribute to local craftsmanship.*

*Amà, viene del catalán "a mà", que significa "hecha a mano", y es como está fabricada esta lámpara. Con madera de haya torneada a mano, detalles en latón macizo, y pantalla tejida a mano, en ratán natural.*

*Mediterránea, simple, elegante.*

*Diseñada por Mariano Chitarrini en Barcelona, e inspirada en las atmósferas de las casas mediterráneas, de los grandes arquitectos del siglo XX.*

*Es un elogio a la artesanía local.*



# AMÀ

Pendant lamp / Lámpara suspendida

The Amà hanging lamp has an option of ø 40 cm (ø 15.7") and ø 30 cm (ø 11.8") lampshades. With its dome shape, it is hand-woven in our workshops, with natural rattan.

Inside, it has a double lamp holder, with room for two E-27 or E-26 bulbs. It is recommended to use LED filament bulbs, warm color. It provides a dim light very pleasing to the eye, which highlights the natural details of the rattan of the lampshade.

It has a continuous vertical upright, which enters the rattan lampshade. Its materiality combines polished brass and colorless varnished beech wood, highlighting the natural beauty of each material. The precision with which the union between these two materials is made, makes a total continuity in the piece.

La lámpara suspendida Amà, tiene opción de pantalla de ø 40 cm (ø 15.7"), y de ø 30 cm (ø 11.8"). Con su forma de cúpula, está tejida a mano en nuestros talleres, con ratán natural.

En su interior, posee un portalámparas doble, con lugar para dos bombillas tipo E-27 o E-26. Se recomienda utilizar bombillas tipo LED de filamentos, color cálido. Proporciona una luz tenue muy agradable a la vista, que resalta los detalles naturales del ratán de la pantalla.

Cuenta con un montante vertical continuo, que entra en la pantalla de ratán. Su materialidad combina latón pulido y madera de haya barnizada incolora, resaltando la belleza natural de cada material. La precisión con la que se realiza la unión entre estos dos materiales, hace que haya una continuidad total en la pieza.

**L0311**

Model L - brass  
Modelo L - latón



Option in brass / Opción en latón

Watch video of the Amà brass collection /  
Ver vídeo colección Amà en latón.

**L0313**

Model M - brass  
Modelo M - latón



46 cm  
18.1"

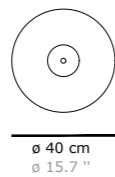
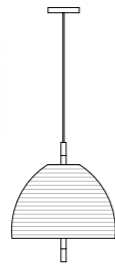

**L0312**

Model L - white  
Modelo L - blanco



Option in white / Opción en blanco

Watch video of the Amà white collection /  
Ver vídeo colección Amà en blanco.

**L0314**

Model M - white  
Modelo M - blanco



35 cm  
13.9"

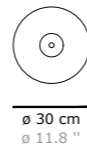
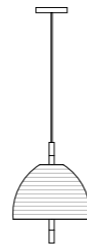

## MATERIALES Y ACABADOS / MATERIALS & FINISHES

Ref. / Ref.	Structure / Estructura	Lampshade / Pantalla	Cable / Cable
<b>L0311 &amp; L0313</b>	Polished brass and beech wood / Latón pulido y madera de haya	Natural rattan / Ratán natural	Textile white / Textil blanco
<b>L0312 &amp; L0314</b>	White metal and beech wood / Metal blanco y madera de haya	Natural rattan / Ratán natural	Textile white / Textil blanco

## RECOMMENDED LIGHT SOURCE / FUENTE DE LUZ RECOMENDADA

2 x E-27 filament LED 12W

## FAMILY / FAMILIA

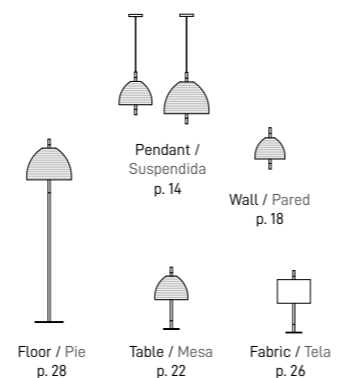







# AMÀ

Wall lamp / Aplique de pared

The wall lamp Amà, has a half dome-shaped screen, hand-woven in our workshops, with natural rattan.

Inside, it has a lamp holder with place for a bulb type E-27 or E-26 of small size Ø45x75 mm. It is recommended to use a LED filament bulb, warm color. It provides a dim light very pleasing to the eye, which highlights the natural details of the rattan of the lampshade. There is the option to order it with a switch at the base of the lamp.

It has a continuous vertical upright, which enters the rattan lampshade. Its materiality combines polished brass and colorless varnished beech wood, highlighting the natural beauty of each material. The precision with which the union between these two materials is made, makes a total continuity in the foot of the lamp.

El aplique de pared Amà, cuenta con una pantalla en forma de media cúpula, tejida a mano en nuestros talleres, con ratán natural.

En su interior, posee un portalámparas con lugar para una bombilla tipo E-27 o E-26 de tamaño pequeño Ø45x75 mm. Se recomienda utilizar una bombilla tipo LED de filamentos, color cálido. Proporciona una luz tenue muy agradable a la vista, que resalta los detalles naturales del ratán de la pantalla. Existe la opción de pedirla con un interruptor en la base de la lámpara.

Cuenta con un montante vertical continuo, que entra en la pantalla de ratán. Su materialidad combina latón pulido y madera de haya barnizada incolora, resaltando la belleza natural de cada material. La precisión con la que se realiza la unión entre estos dos materiales, hace que haya una continuidad total en el pie de la lámpara.

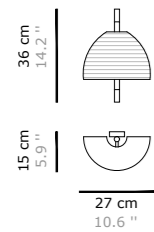

L0341



Option in brass / Opción en latón



Watch video of the Amà brass collection / Ver vídeo colección Amà en latón.

L0342



Option in white / Opción en blanco



Watch video of the Amà white collection / Ver vídeo colección Amà en blanco.

## MATERIALES Y ACABADOS / MATERIALS & FINISHES

Ref. / Ref.	Structure / Estructura	Lampshade / Pantalla
L0341	Polished brass and beech wood / Latón pulido y madera de haya	Natural rattan / Ratán natural
L0342	White and beech wood / Blanco y madera de haya	Natural rattan / Ratán natural

## RECOMMENDED LIGHT SOURCE / FUENTE DE LUZ RECOMENDADA

1 x E-27 filament LED 12W - small size Ø45x75 mm



## FAMILY / FAMILIA

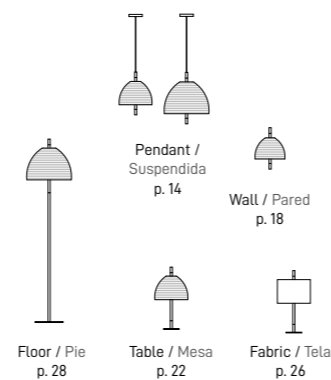







# AMÀ

Table lamp / Lámpara de sobremesa

The Amà table lamp has a lampshade of  $\varnothing$  30 cm ( $\varnothing$  11.8"), and 22 cm (8.7") high. Its dome-shaped lampshade is hand-woven in our workshops with natural rattan.

Inside, it has a double lamp holder, with room for two E-27 or E-26 bulbs. It is recommended to use LED filament bulbs, warm color. It provides a dim light very pleasing to the eye, which highlights the natural details of the rattan of the lampshade. It is turned on with a handle located inside the lampshade.

It has a continuous vertical upright, which enters the rattan lampshade. Its materiality combines polished brass and colorless varnished beech wood, highlighting the natural beauty of each material. The precision with which the union between these two materials is made, makes a total continuity in the foot of the lamp.

La lámpara de sobremesa Amà, cuenta con una pantalla de  $\varnothing$  30 cm ( $\varnothing$  11.8"), y 22 cm (8.7") de alto. Su pantalla en forma de cúpula, está tejida a mano en nuestros talleres, con ratán natural.

En su interior, posee un portalámparas doble, con lugar para dos bombillas tipo E-27 o E-26. Se recomienda utilizar bombillas tipo LED de filamentos, color cálido. Proporciona una luz tenue muy agradable a la vista, que resalta los detalles naturales del ratán de la pantalla. Se enciende con un tirador ubicado dentro de la pantalla.

Cuenta con un montante vertical continuo, que entra en la pantalla de ratán. Su materialidad combina latón pulido y madera de haya barnizada incolora, resaltando la belleza natural de cada material. La precisión con la que se realiza la unión entre estos dos materiales, hace que haya una continuidad total en el pie de la lámpara.

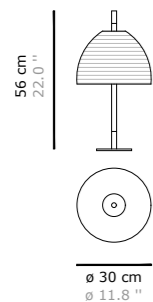

L0331



Option in brass / Opción en latón



Watch video of the Amà brass collection / Ver vídeo colección Amà en latón.

L0332



Option in white / Opción en blanco



Watch video of the Amà white collection / Ver vídeo colección Amà en blanco.

## MATERIALES Y ACABADOS / MATERIALS & FINISHES

Ref. / Ref.	Structure / Estructura	Lampshade / Pantalla	Cable / Cable
L0331	Polished brass and beech wood / Latón pulido y madera de haya	Natural rattan / Ratán natural	White PVC / PVC blanco
L0332	White and beech wood / Blanco y madera de haya	Natural rattan / Ratán natural	White PVC / PVC blanco

## RECOMMENDED LIGHT SOURCE / FUENTE DE LUZ RECOMENDADA

2 x E-27 filament LED 12W



## FAMILY / FAMILIA

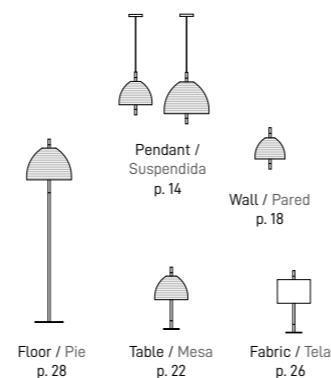







# AMÀ

Table lamp / Lámpara de sobremesa

The Amà lamp model offers a variant with a natural textured fabric shade in white.

At the top, the fabric folds to hide the light source, creating a unique detail.

As in the rattan version, its foot combines polished brass with hand-turned beech wood.

El modelo de lámpara Amà ofrece una variante con pantalla de tela de textura natural, en color blanco.

En la parte superior, la tela se pliega para ocultar la fuente de luz, creando un detalle único.

Como en la versión de ratán, su pie combina el latón pulido con la madera de haya torneada a mano.



L0431

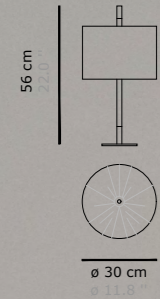
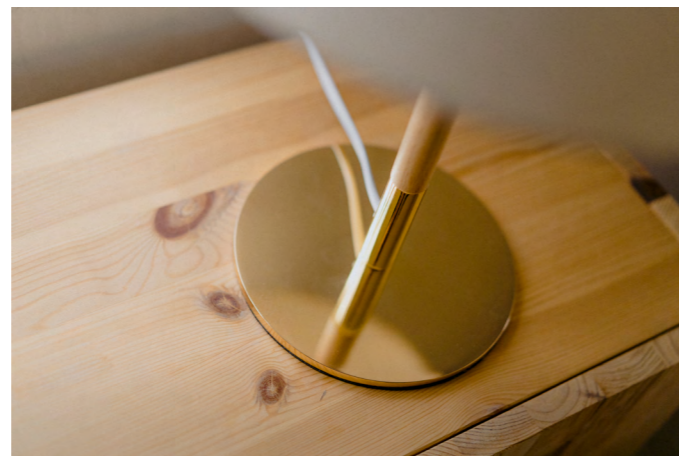

## MATERIALES Y ACABADOS / MATERIALS & FINISHES

Ref. / Ref.	Structure / Estructura	Lampshade / Pantalla	Cable / Cable
L0431	Polished brass and beech wood / Latón pulido y madera de haya	Natural fabric / Tela color crudo	White PVC / PVC blanco

## RECOMMENDED LIGHT SOURCE / FUENTE DE LUZ RECOMENDADA

2 x E-27 LED 12W



## FAMILY / FAMILIA

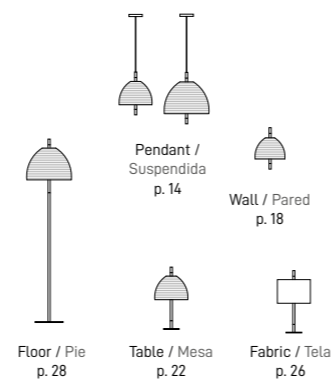



# AMÀ

Floor lamp / Lámpara de pie

The Amà floor lamp has a shade of ø 40 cm (ø 15.7"), and 29 cm (11.4") high. It has a dome shape and is hand-woven in our workshops, with natural rattan.

Inside, it has a double lamp holder, with room for two E-27 or E-26 bulbs. It is recommended to use LED filament bulbs, warm color. It provides a dim light very pleasing to the eye, which highlights the natural details of the rattan of the lampshade. It is turned on with a handle located inside the lampshade.

It has with a continuous vertical upright, which enters the rattan lampshade. Its materiality combines polished brass and colorless varnished beech wood, highlighting the natural beauty of each material. The precision with which the union between these two materials is made, makes a total continuity in the foot of the lamp.

La lámpara de pie Amà, cuenta con una pantalla de ø 40 cm (ø 15.7"), y 29 cm (11.4") de alto. Tiene forma de cúpula y está tejida a mano en nuestros talleres, con ratán natural.

En su interior, posee un portalámparas doble, con lugar para dos bombillas tipo E-27 o E-26. Se recomienda utilizar bombillas tipo LED de filamentos, color cálido. Proporciona una luz tenue muy agradable a la vista, que resalta los detalles naturales del ratán de la pantalla. Se enciende con un tirador ubicado dentro de la pantalla.

Tiene con un montante vertical continuo, que entra en la pantalla de ratán. Su materialidad combina latón pulido y madera de haya barnizada incolora, resaltando la belleza natural de cada material. La precisión con la que se realiza la unión entre estos dos materiales, hace que haya una continuidad total en el pie de la lámpara.

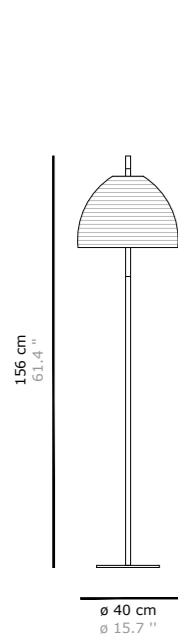

L0321  
Option in brass /  
Opción en latón

▶ Watch video of the Amà brass collection /  
Ver vídeo colección Amà en latón.



L0322  
Option in white /  
Opción en blanco

▶ Watch video of the Amà white collection /  
Ver vídeo colección Amà en blanco.

## MATERIALES Y ACABADOS / MATERIALS & FINISHES

Ref. / Ref.	Structure / Estructura	Lampshade / Pantalla	Cable / Cable
L0321	Polished brass and beech wood / Latón pulido y madera de haya	Natural rattan / Ratán natural	White PVC / PVC blanco
L0322	White and beech wood / Blanco y madera de haya	Natural rattan / Ratán natural	White PVC / PVC blanco

## RECOMMENDED LIGHT SOURCE / FUENTE DE LUZ RECOMENDADA

2 x E-27 vintage LED 12W

IP20 CE

## FAMILY / FAMILIA

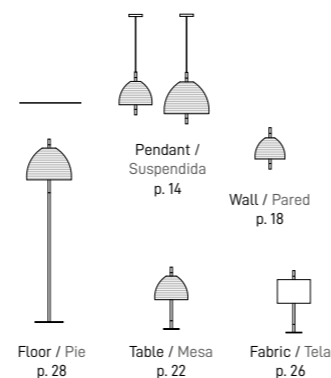







ÀMA collection in brass /  
Colección ÀMA en latón.



ÀMA collection in white /  
Colección ÀMA en blanco.







# SUAU

## LAMP COLLECTION

2022  
Designed by Mariano Chitarrini

*Suau lamps are designed and manufactured by Mediterranean Objects in Barcelona, Spain.*

*They have an external screen made of MDF wooden slats, laser cut and assembled one by one, in such a way that they create two different visual textures, one thicker, and the other more open.*

*Another interior lampshade, made of paper and PVC, special for lamps, is off-white in colour, and diffuses the light, creating a soft atmosphere and pleasant ambient light.*

*Las lámparas Suau están diseñadas y fabricadas por Mediterranean Objects en Barcelona, España.*

*Tienen una pantalla exterior de lamas de madera de MDF, cortadas a láser y ensambladas una a una, de forma que crean dos texturas visuales diferentes, una más tupida, y otra más abierta.*

*Otra pantalla interior, de papel y pvc especial para lámparas, es de color blanco roto, y difumina la luz, creando una atmósfera suave y luz de ambiente agradable.*



# SUAU

Pendant lamp large / Lámpara suspendida larga

SUAU lamps have an outer lampshade made of MDF wooden slats, laser cut and assembled one by one, creating two different visual textures, one more dense and the other more open.

Another inner shade, which is off-white, diffuses the light, creating a soft atmosphere and a pleasant ambient light.

With space for two bulbs, its elongated size is ideal for placement in bars or rectangular tables, as well as in living room centers. In addition, it features a horizontal oval shade at the bottom to hide the bulbs from view.

Las lámparas SUAU tienen una pantalla exterior de listones de madera MDF, cortados con láser y ensamblados uno a uno, creando dos texturas visuales diferentes, una más densa y otra más abierta.

Otra pantalla interior, es de color blanco hueso, y difunde la luz, creando una atmósfera suave y una agradable luz ambiental.

Tiene espacio para dos bombillas. Su tamaño alargado es ideal para colocar en barras o mesas rectangulares, así como en centros de salón.

Además, cuenta con una pantalla ovalada horizontal en la parte inferior para ocultar las bombillas de la vista.

L0671

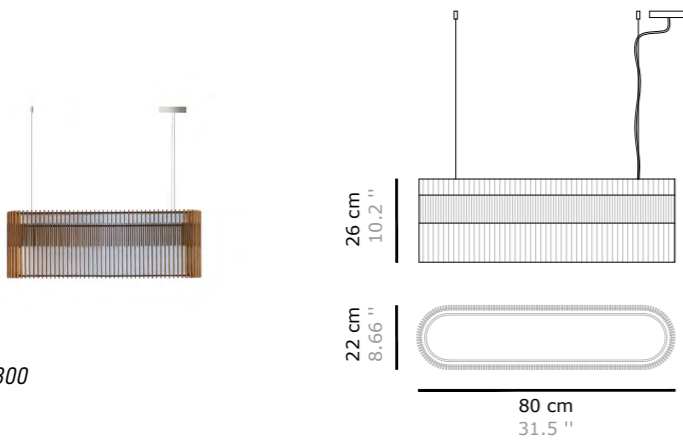

Model L800

▶ Watch video of the Suau L800 lamp /  
Ver vídeo de lámpara Suau L800.

L0681

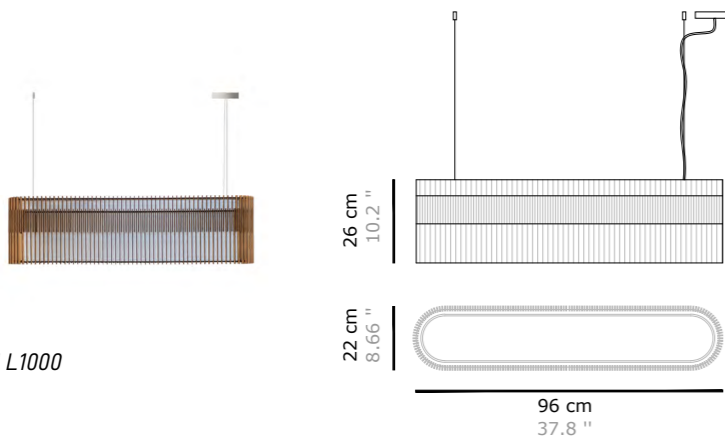

Model L1000

▶ Watch video of the Suau L1000 lamp /  
Ver vídeo de lámpara Suau L1000.

## MATERIALES Y ACABADOS / MATERIALS & FINISHES

Ref. / Ref.	Lampshade / Pantalla	Cable / Cable
L0671	Natural MDF wood and translucent interior shade /	Textile /
L0681	Madera MDF natural y pantalla interior translúcida.	Textil

## INCLUDED LIGHT SOURCE / FUENTE DE LUZ INCLUIDA

Ref. L0671: LED strip 10W 1056 Lm - 3000°K

Ref. L0681: LED strip 13W 1408 Lm - 3000°K

⚡ ⚡ IP20 CE

## FAMILY / FAMILIA

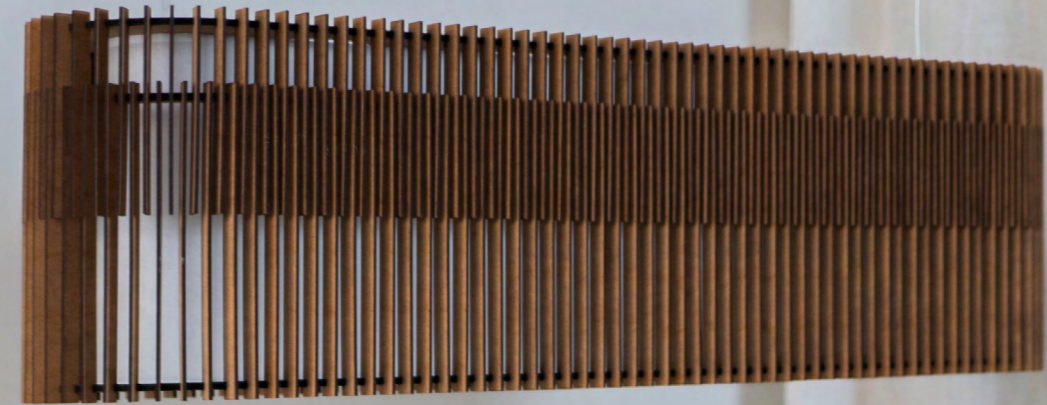
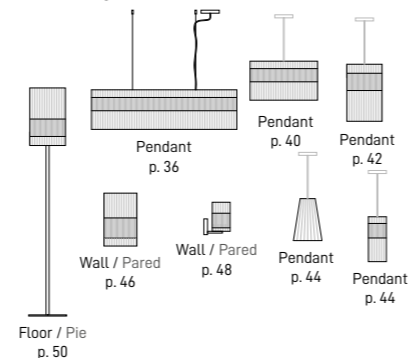



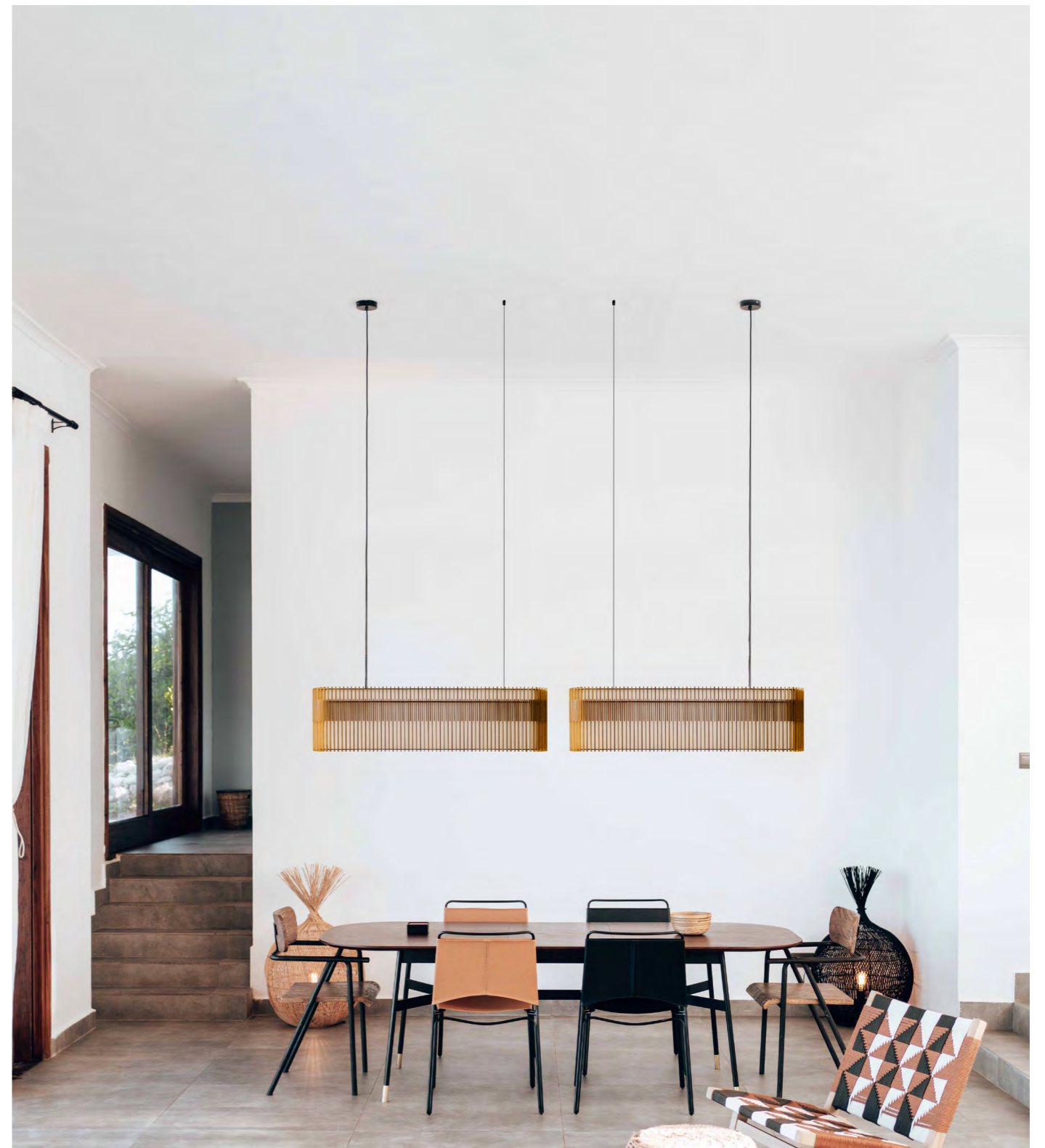



# SUAU

Pendant XL / Lámpara suspendida XL

SUAU lamps have an outer lampshade made of MDF wooden slats, laser cut and assembled one by one, creating two different visual textures, one more dense and the other more open.

Another inner shade, which is off-white, diffuses the light, creating a soft atmosphere and a pleasant ambient light.

It has space for one bulb. Its larger size than the M model makes it ideal for dining rooms and living rooms, especially on the table, and it has a horizontal flat shade at the bottom to hide the bulbs from view.

Las lámparas SUAU tienen una pantalla exterior de listones de madera MDF, cortados con láser y ensamblados uno a uno, creando dos texturas visuales diferentes, una más densa y otra más abierta.

Otra pantalla interior, es de color blanco hueso, y difunde la luz, creando una atmósfera suave y una agradable luz ambiental.

Tiene espacio para una bombilla. Su mayor tamaño que el modelo M, hace que sea ideal para comedores y salones, especialmente sobre la mesa.

Además, cuenta con una pantalla plana horizontal en la parte inferior para ocultar las bombillas de la vista.

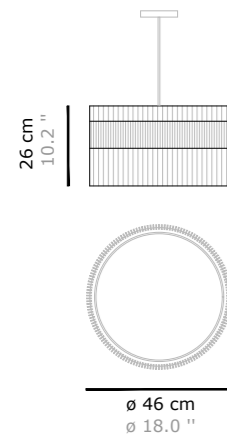

L0661



Watch video of the Suau XL lamp /  
Ver vídeo de lámpara Suau XL.



## MATERIALES Y ACABADOS / MATERIALS & FINISHES

Ref. / Ref.	Lampshade / Pantalla	Cable / Cable
L0661	Natural MDF wood and translucent interior shade / Madera MDF natural y pantalla interior translúcida.	Textile / Textil

## RECOMMENDED LIGHT SOURCE / FUENTE DE LUZ RECOMENDADA

1 x E-27 LED 12W



## FAMILY / FAMILIA

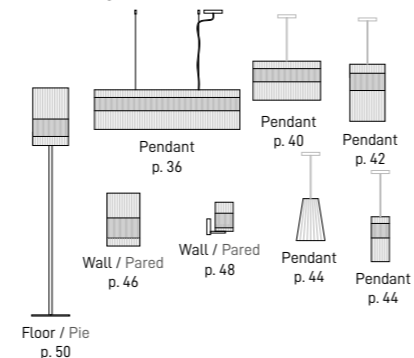



# SUAU

Pendant M / Lámpara suspendida M

SUAU lamps have an outer lampshade made of MDF wooden slats, laser cut and assembled one by one, creating two different visual textures, one more dense and the other more open.

Another inner shade, which is off-white, diffuses the light, creating a soft atmosphere and a pleasant ambient light.

It has room for a light bulb. Its medium size gives it the flexibility to occupy many different spaces, fitting well in large spaces as well as in smaller spaces.

Las lámparas SUAU tienen una pantalla exterior de listones de madera MDF, cortados con láser y ensamblados uno a uno, creando dos texturas visuales diferentes, una más densa y otra más abierta.

Otra pantalla interior, es de color blanco hueso, y difunde la luz, creando una atmósfera suave y una agradable luz ambiental.

Tiene lugar para una bombilla. Su tamaño mediano, le da flexibilidad para ocupar muchos espacios diferentes, quedando bien en espacios grandes como en espacios más reducidos.

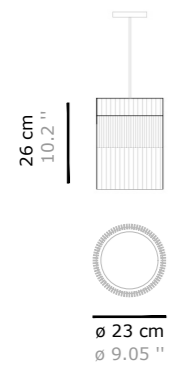

L0641



[Watch video of the Suau M lamp / Ver vídeo de lámpara Suau M.](#)



## MATERIALES Y ACABADOS / MATERIALS & FINISHES

Ref. / Ref.	Lampshade / Pantalla	Cable / Cable
L0641	Natural MDF wood and translucent interior shade / Madera MDF natural y pantalla interior translúcida.	Textile / Textil

## RECOMMENDED LIGHT SOURCE / FUENTE DE LUZ RECOMENDADA

1 x E-27 LED 12W

## FAMILY / FAMILIA

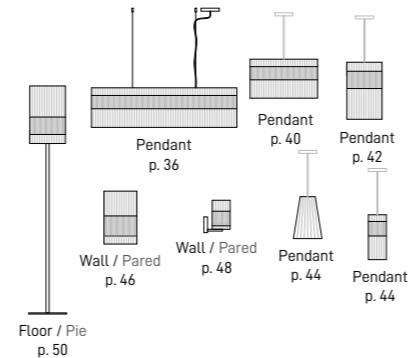



# SUAU

Pendant cone and slim / Lámpara suspendida cono y esbelta

SUAU lamps have an outer lampshade made of MDF wooden slats, laser cut and assembled one by one, creating two different visual textures, one more dense and the other more open.

Las lámparas SUAU tienen una pantalla exterior de listones de madera MDF, cortados con láser y ensamblados uno a uno, creando dos texturas visuales diferentes, una más densa y otra más abierta.

Another inner shade, which is off-white, diffuses the light, creating a soft atmosphere and a pleasant ambient light.

Otra pantalla interior, es de color blanco hueso, y difunde la luz, creando una atmósfera suave y una agradable luz ambiental.

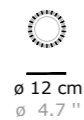
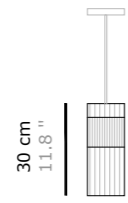
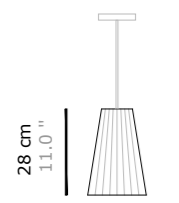

L0651



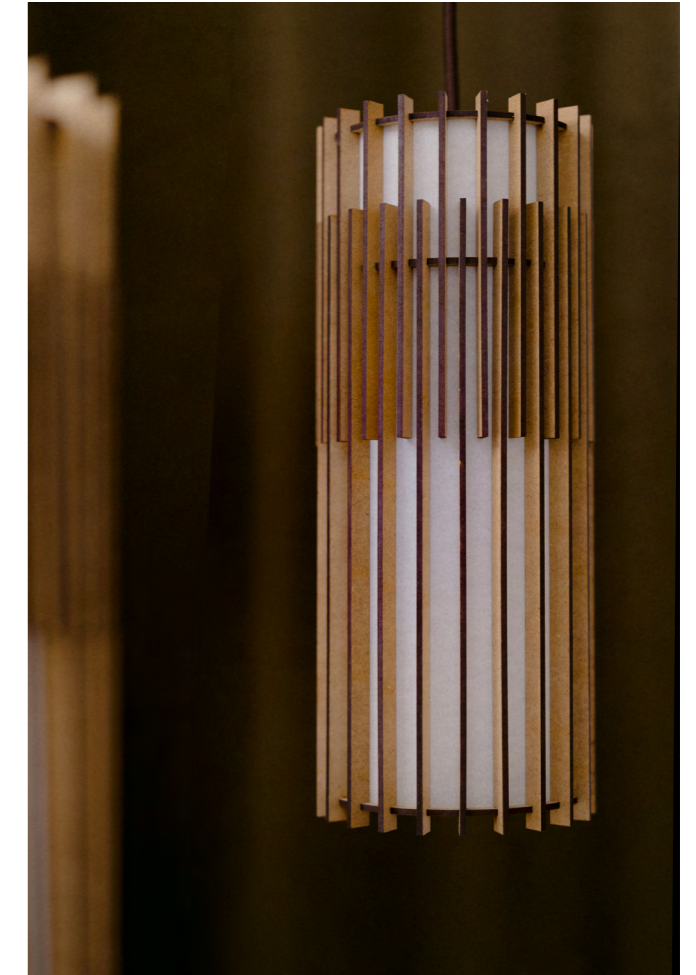

L0691



## MATERIALES Y ACABADOS / MATERIALS & FINISHES

Ref. / Ref.	Lampshade / Pantalla	Cable / Cable
L0651	Natural MDF wood and translucent interior shade /	Textile /
L0691	Madera MDF natural y pantalla interior translúcida.	Textil

## RECOMMENDED LIGHT SOURCE / FUENTE DE LUZ RECOMENDADA

1 x E-27 LED 12W  
  IP20 

## FAMILY / FAMILIA

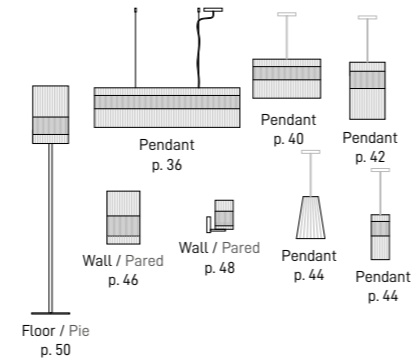



# SUAU

Wall lamp R / Aplique de pared R

SUAU lamps have an outer lampshade made of MDF wooden slats, laser cut and assembled one by one, creating two different visual textures, one more dense and the other more open.

Another inner shade, which is off-white, diffuses the light, creating a soft atmosphere and a pleasant ambient light.

Ideal for hallways, as a bedside night light or as a decorative piece in any room.

Las lámparas SUAU tienen una pantalla exterior de listones de madera MDF, cortados con láser y ensamblados uno a uno, creando dos texturas visuales diferentes, una más densa y otra más abierta.

Otra pantalla interior, es de color blanco hueso, y difunde la luz, creando una atmósfera suave y una agradable luz ambiental.

Ideal para pasillos, como luz de noche junto a la cama o como pieza decorativa en cualquier habitación.

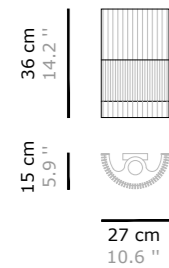

L0621



[Watch video of the Suau wall lamp / Ver vídeo de lámpara Suau wall.](#)



## MATERIALES Y ACABADOS / MATERIALS & FINISHES

Ref. / Lampshade /  
Ref. / Pantalla

L0621 Natural MDF wood and translucent interior shade /  
Madera MDF natural y pantalla interior translúcida.

## RECOMMENDED LIGHT SOURCE / FUENTE DE LUZ RECOMENDADA

1 x E-27 LED 12W

⊕ Ⓜ IP20 CE

## FAMILY / FAMILIA

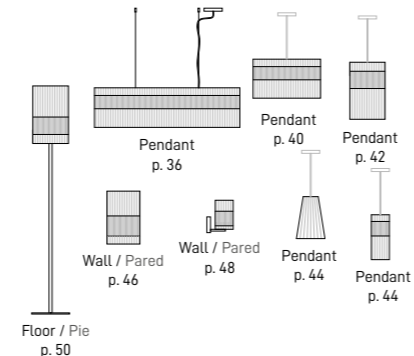



# SUAU

Wall lamp S / Applique de pared S

SUAU lamps have an outer lampshade made of MDF wooden slats, laser cut and assembled one by one, creating two different visual textures, one more dense and the other more open.

Las lámparas SUAU tienen una pantalla exterior de listones de madera MDF, cortados con láser y ensamblados uno a uno, creando dos texturas visuales diferentes, una más densa y otra más abierta.

Another inner shade, which is off-white, diffuses the light, creating a soft atmosphere and a pleasant ambient light.

Otra pantalla interior, es de color blanco hueso, y difunde la luz, creando una atmósfera suave y una agradable luz ambiental.

L0611

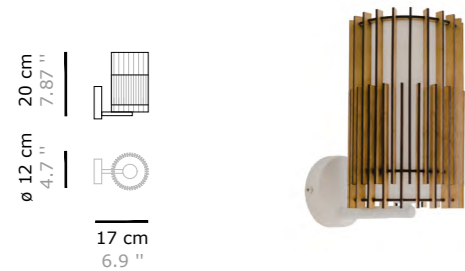

▶ Watch video of the Suau wall lamp S /  
Ver vídeo de lámpara Suau applique S.

L0612



▶ Watch video of the Suau S in brass /  
Ver vídeo de lámpara Suau S en latón.



## MATERIALES Y ACABADOS / MATERIALS & FINISHES

Ref. / Lampshade /  
Ref. Pantalla

L0611 Natural MDF wood and translucent interior shade /  
Madera MDF natural y pantalla interior translúcida.

## RECOMMENDED LIGHT SOURCE / FUENTE DE LUZ RECOMENDADA

1 x E-27 LED 12W

⊕ Ⓜ IP20 CE

## FAMILY / FAMILIA

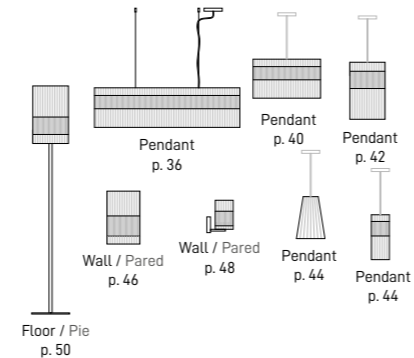



# SUAU

Floor lamp / Lámpara de pie

SUAU lamps have an outer lampshade made of MDF wooden slats, laser cut and assembled one by one, creating two different visual textures, one more dense and the other more open.

Las lámparas SUAU tienen una pantalla exterior de listones de madera MDF, cortados con láser y ensamblados uno a uno, creando dos texturas visuales diferentes, una más densa y otra más abierta.

Another inner shade, which is off-white, diffuses the light, creating a soft atmosphere and a pleasant ambient light.

Otra pantalla interior, es de color blanco hueso, y difunde la luz, creando una atmósfera suave y una agradable luz ambiental.

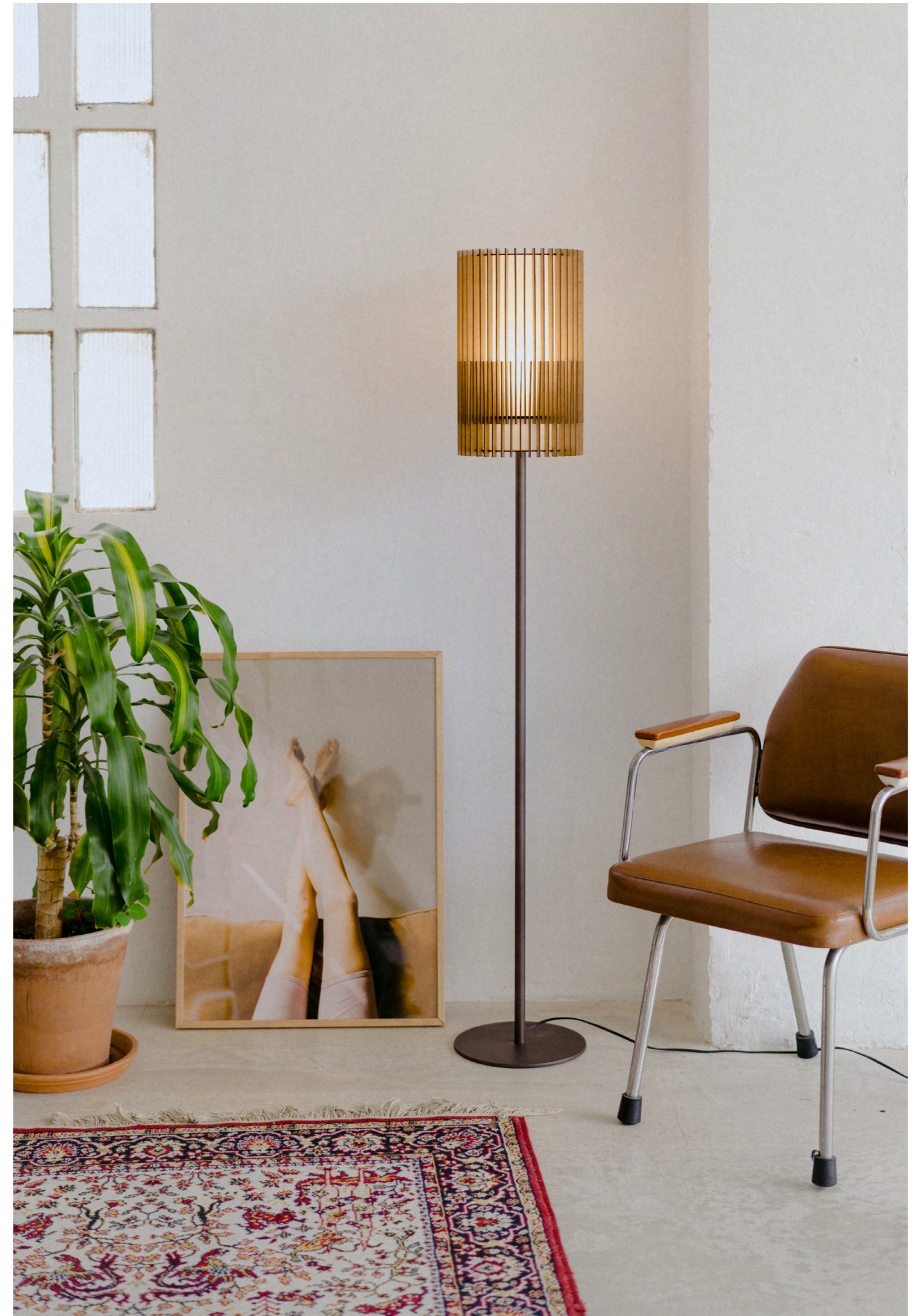
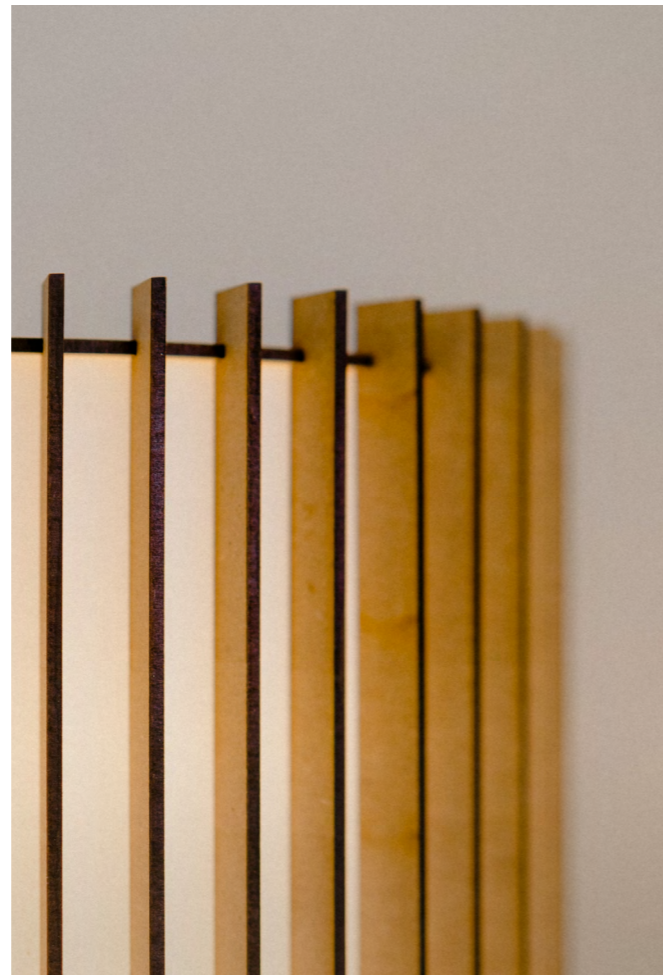
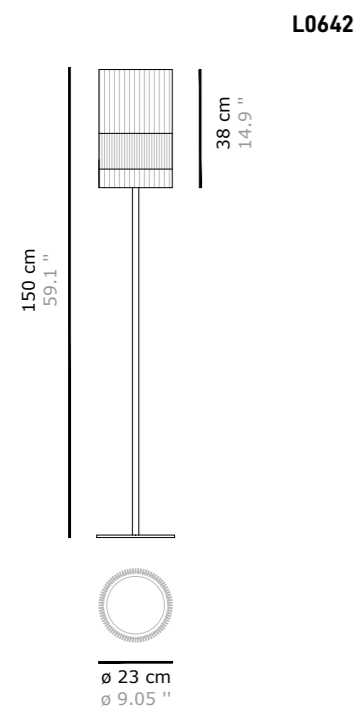

## MATERIALES Y ACABADOS / MATERIALS & FINISHES

Ref. / Ref.	Lampshade / Pantalla	Cable / Cable
L0642	Natural MDF wood and translucent interior shade / Madera MDF natural y pantalla interior translúcida.	Pvc / Pvc

## RECOMMENDED LIGHT SOURCE / FUENTE DE LUZ RECOMENDADA

1 x E-27 LED 12W

## FAMILY / FAMILIA

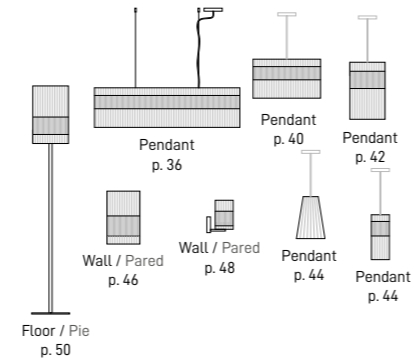



# COSTA

Cylindrical wall lamps / Apliques de pared cilíndricos

The Costa wall lamps are natural rattan luminaires, hand-woven in our artisan workshop.

It is recommended to use them with warm bulbs, led, filament; to project the texture of the rattan on the surfaces.

Ideal for hallways, as a bedside night light, or as a decorative piece in any room.

Los apliques Costa son luminarias de ratán natural tejido a mano en nuestro taller artesanal.

Se recomienda utilizarlas con bombillas cálidas, led, de filamento; para que proyecten la textura del ratán sobre las superficies.

Ideal para pasillos, como luz de noche a los laterales de la cama, o como pieza decorativa en cualquier estancia.

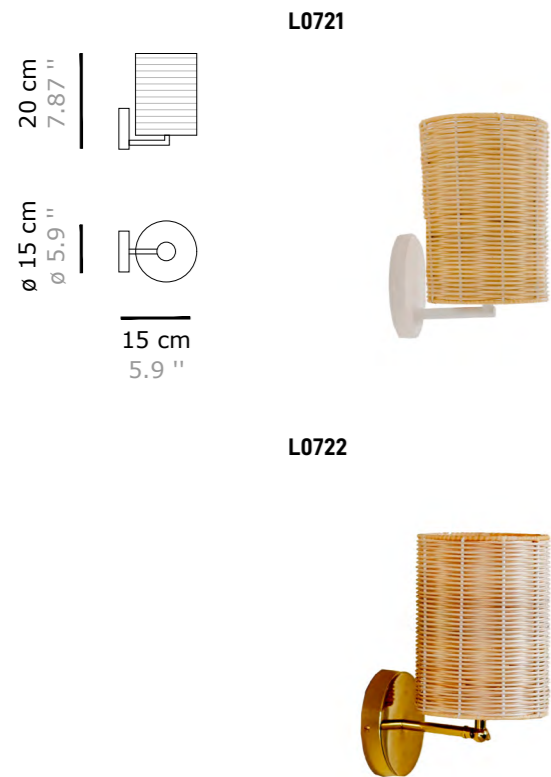

Watch video of the Costa cylindrical in brass / Ver vídeo de lámpara Costa cilindro en latón.



## MATERIALES Y ACABADOS / MATERIALS & FINISHES

Ref. / Ref.	Lampshade / Pantalla	Structure / Estructura
L0721	Natural rattan / Ratán natural	White / Blanco
L0722	Natural rattan / Ratán natural	Brass / Latón

## RECOMMENDED LIGHT SOURCE / FUENTE DE LUZ RECOMENDADA

1 x E-27 LED 12W - Filament bulb / Bombilla de filamento

⊕ Ⓢ IP20 CE

## FAMILY / FAMILIA

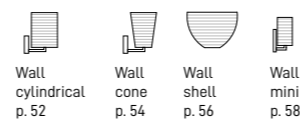
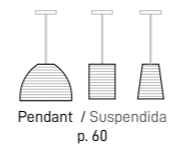



# COSTA

Cylindrical wall lamps / Apliques de pared cilíndricos

The Costa wall lamps are natural rattan luminaires, hand-woven in our artisan workshop.

It is recommended to use them with warm bulbs, led, filament; to project the texture of the rattan on the surfaces.

Ideal for hallways, as a bedside night light, or as a decorative piece in any room.

Los apliques Costa son luminarias de ratán natural tejido a mano en nuestro taller artesanal.

Se recomienda utilizarlas con bombillas cálidas, led, de filamento; para que proyecten la textura del ratán sobre las superficies.

Ideal para pasillos, como luz de noche a los laterales de la cama, o como pieza decorativa en cualquier estancia.

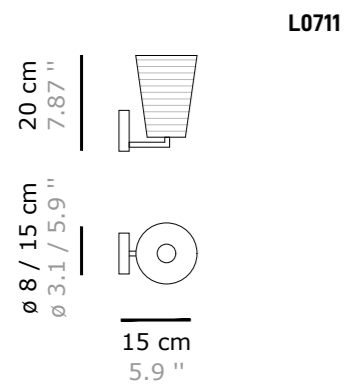

**L0712**



▶ Watch video of the Costa cone in brass / Ver video de lámpara Costa cono en latón.



## MATERIALES Y ACABADOS / MATERIALS & FINISHES

Ref. / Ref.	Lampshade / Pantalla	Structure / Estructura
L0711	Natural rattan / Ratán natural	White / Blanco
L0712	Natural rattan / Ratán natural	Brass / Latón

## RECOMMENDED LIGHT SOURCE / FUENTE DE LUZ RECOMENDADA

1 x E-27 LED 12W - Filament bulb / Bombilla de filamento

⊕ Ⓜ IP20 CE

## FAMILY / FAMILIA

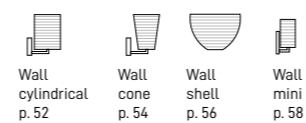
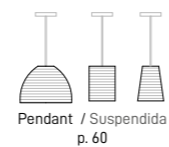



# COSTA

Cylindrical wall lamps / Apliques de pared cilíndricos

The Costa wall lamps are natural rattan luminaires, hand-woven in our artisan workshop.

It is recommended to use them with warm bulbs, led, filament; to project the texture of the rattan on the surfaces.

Ideal for hallways, as a bedside night light, or as a decorative piece in any room.

Los apliques Costa son luminarias de ratán natural tejido a mano en nuestro taller artesanal.

Se recomienda utilizarlas con bombillas cálidas, led, de filamento; para que proyecten la textura del ratán sobre las superficies.

Ideal para pasillos, como luz de noche a los laterales de la cama, o como pieza decorativa en cualquier estancia.

L0761

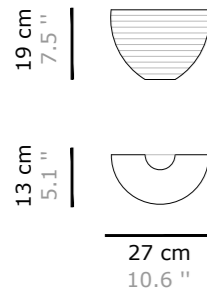

 Watch video of the Costa shell wall lamp/  
Ver vídeo de lámpara de pared Costa shell.



## MATERIALES Y ACABADOS / MATERIALS & FINISHES

Ref. / Lampshade /  
Ref. Pantalla

L0761 Natural rattan / Ratán natural

## RECOMMENDED LIGHT SOURCE / FUENTE DE LUZ RECOMENDADA

1 x E-27 LED 12W - Filament bulb / Bombilla de filamento



## FAMILY / FAMILIA

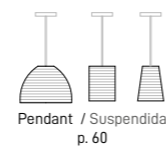

Pendant / Suspendida  
p. 60



Wall cylindrical  
p. 52



Wall cone  
p. 54



Wall shell  
p. 56



Wall mini  
p. 58





# COSTA

Cylindrical wall lamps / Apliques de pared cilíndricos

The Costa wall lamps are natural rattan luminaires, hand-woven in our artisan workshop.

It is recommended to use them with warm bulbs, led, filament; to project the texture of the rattan on the surfaces.

Ideal for hallways, as a bedside night light, or as a decorative piece in any room.

Los apliques Costa son luminarias de ratán natural tejido a mano en nuestro taller artesanal.

Se recomienda utilizarlas con bombillas cálidas, led, de filamento; para que proyecten la textura del ratán sobre las superficies.

Ideal para pasillos, como luz de noche a los laterales de la cama, o como pieza decorativa en cualquier estancia.

L0772

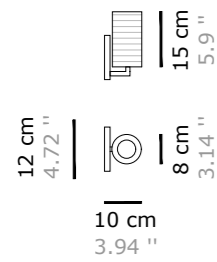

Watch video of the Costa mini wall lamp/  
Ver vídeo de lámpara de pared Costa mini.



## MATERIALES Y ACABADOS / MATERIALS & FINISHES

Ref. / Lampshade /  
Ref. Pantalla

L0772 Natural rattan / Ratán natural

## RECOMMENDED LIGHT SOURCE / FUENTE DE LUZ RECOMENDADA

1 x E-27 filament LED 12W - small size Ø45x75 mm

## FAMILY / FAMILIA

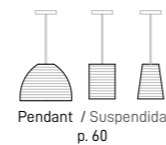

Wall cylindrical  
p. 52



Wall cone  
p. 54



Wall shell  
p. 56



Wall mini  
p. 58





# COSTA

Pendant lamps / Lámparas suspendidas

The Costa pendant lamps are small natural rattan luminaires, hand-woven in our artisan workshop.

It is recommended to use them with warm bulbs, led, filament; to project the texture of the rattan on the surfaces.

Ideal for hallways, as a bedside night light, or as a decorative piece in any room.

Las luminarias Costa son pequeñas luminarias de ratán natural tejido a mano en nuestro taller artesanal.

Se recomienda utilizarlas con bombillas cálidas, led, de filamento; para que proyecten la textura del ratán sobre las superficies.

Ideal para pasillos, como luz de noche a los laterales de la cama, o como pieza decorativa en cualquier estancia.

L0731

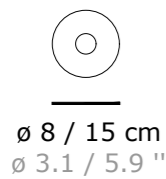
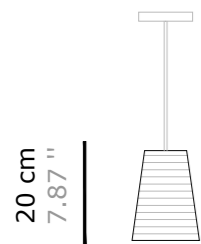

L0741

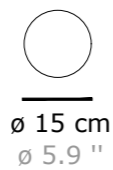
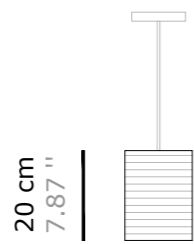

L0751

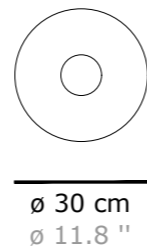
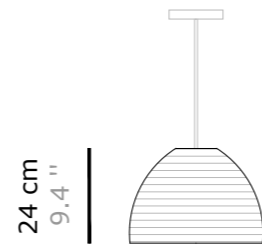

## MATERIALES Y ACABADOS / MATERIALS & FINISHES

Ref. / Ref.	Lampshade / Pantalla	Cable
L0731	Natural rattan / Ratán natural	Textile / Textil
L0741		Textil
L0751		

## RECOMMENDED LIGHT SOURCE / FUENTE DE LUZ RECOMENDADA

1 x E-27 LED 12W

## FAMILY / FAMILIA

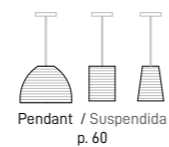

Pendant / Suspendida  
p. 60



Wall cylindrical  
p. 52



Wall cone  
p. 54



Wall shell  
p. 56



Wall mini  
p. 58

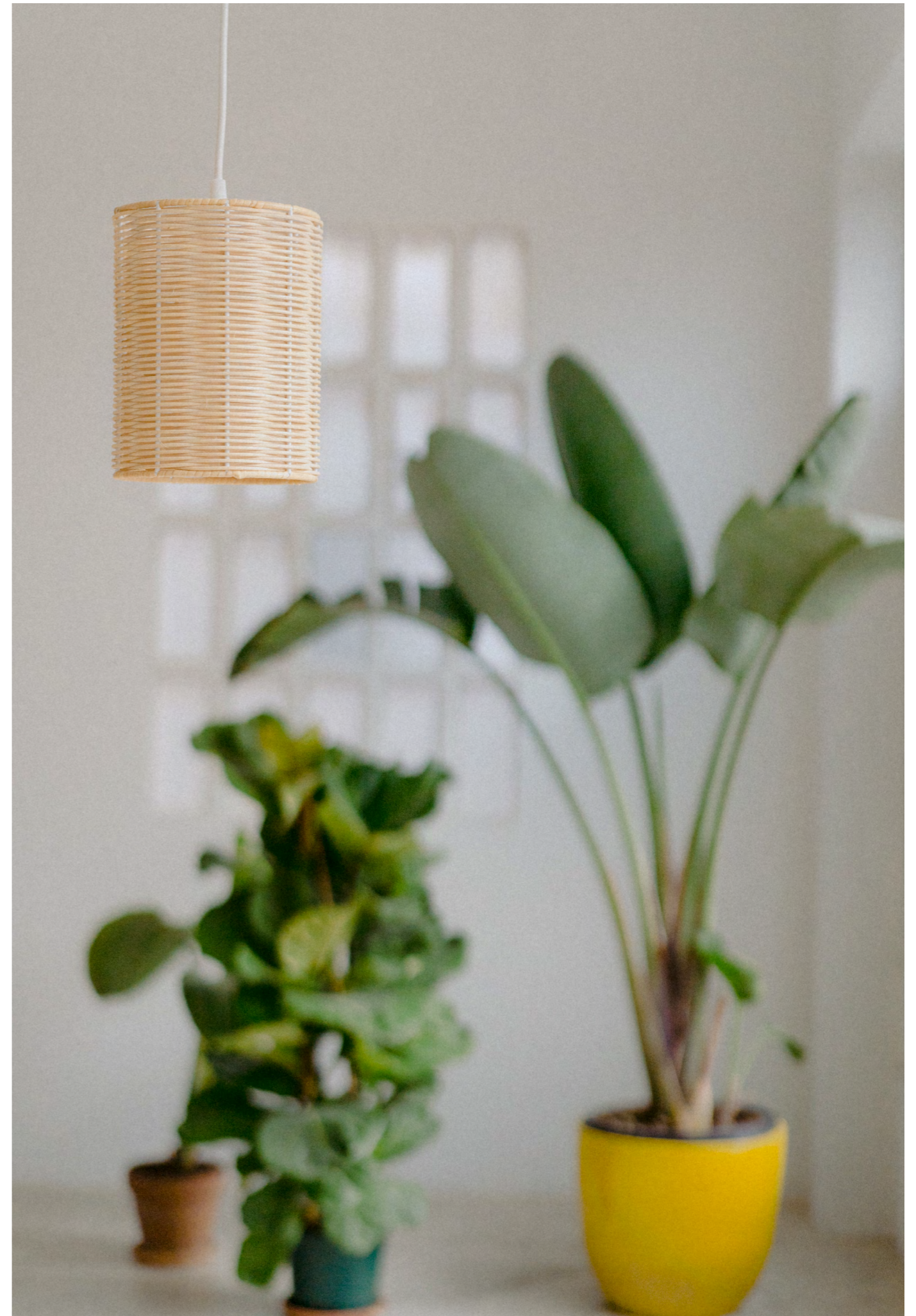







# VOL

Pendant 120 cm / Lámpara suspendida 120cm

The VOL pendant lamp has a simple combination of lines and volumes, which create an elongated sculptural shape, that gives a sophisticated ambient light.

It has a cylindrical shade, a structure that combines brass with natural wood, and an inner LED strip.

La lámpara suspendida VOL presenta una sencilla combinación de líneas y volúmenes, que crean una forma escultural alargada, que proporciona una sofisticada luz ambiental.

Cuenta con una pantalla cilíndrica, una estructura que combina el latón con la madera natural y una tira LED interior.

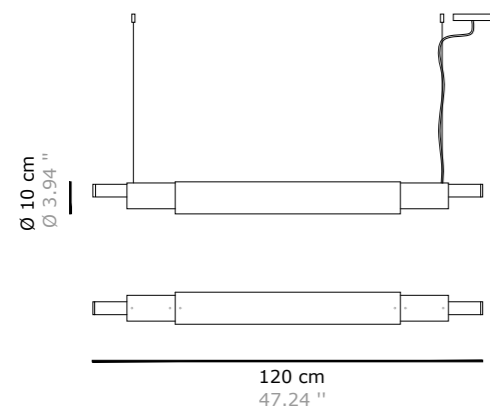

L0911



 Watch video of the Vol pendant lamp /  
Ver vídeo de lámpara Vol suspendida.

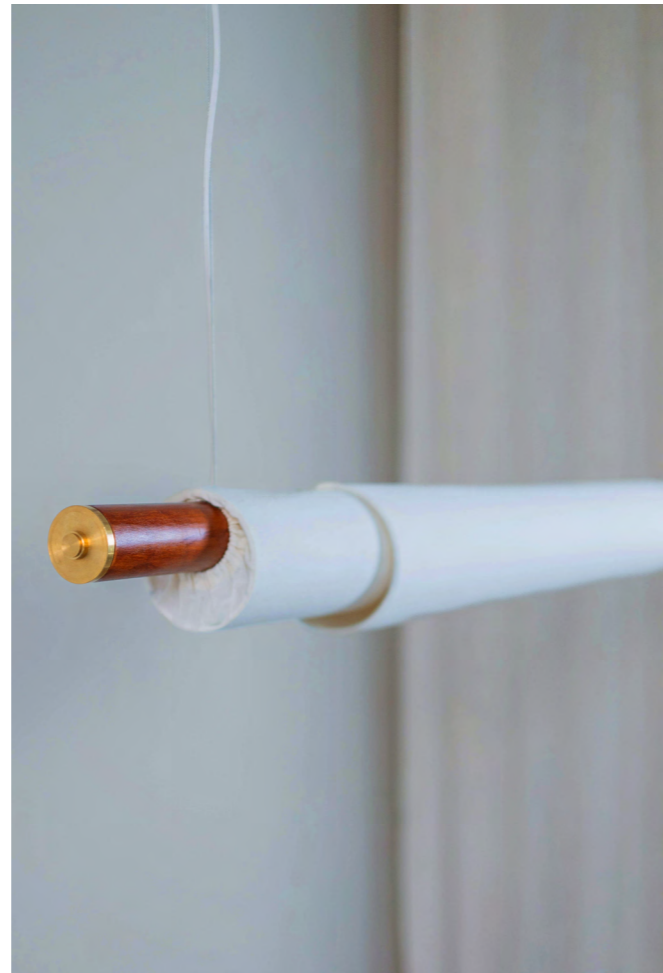

## MATERIALES Y ACABADOS / MATERIALS & FINISHES

Ref. / Ref.	Lampshade / Pantalla	Cable / Cable
L0911	Cherry stained beech wood, brass, white lampshade. / Madera de haya teñida en cerezo, latón, pantalla blanca.	Textile / Textil

## INCLUDED LIGHT SOURCE / FUENTE DE LUZ INCLUIDA

LED strip 14.4W, 1584 Lm - 3000°K

  IP20 





# VOL

Table lamp / Lámpara de sobremesa

The VOL table lamp has a simple combination of lines and volumes, which create a geometric sculptural form, while being optimal in its shape for lighting spaces.

It has a conical shade, a structure that combines metal with natural wood, and a four-arm base.

La lámpara de sobremesa VOL presenta una sencilla combinación de líneas y volúmenes, que crean una forma escultórica geométrica, a la vez que óptima en su forma para iluminar espacios.

Tiene una pantalla cónica, una estructura que combina metal con madera natural y una base de cuatro pies.



L0931



Option in fabric / Opción en tela

L0932



Option in rattan / Opción en ratán

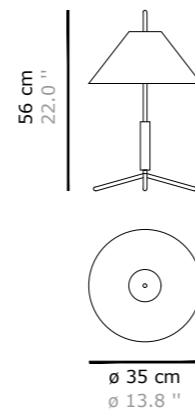

[▶ Watch video of the Vol table brass-fabric / Ver vídeo Vol sobremesa latón-tela.](#)

[▶ Watch video of the Vol table brass-rattan / Ver vídeo Vol sobremesa latón-ratán.](#)

## MATERIALES Y ACABADOS / MATERIALS & FINISHES

Ref. / Ref.	Structure / Estructura	Lampshade / Pantalla	Cable / Cable
L0931	Polished brass and beech wood / Latón pulido y madera de haya	White fabric / Tela blanca	Textile / Textil
L0932	Polished brass and beech wood / Latón pulido y madera de haya	Natural rattan / Ratán natural	Textile / Textil

## RECOMMENDED LIGHT SOURCE / FUENTE DE LUZ RECOMENDADA

L0931: 2 x E-27 LED 12W

L0932: 2 x E-27 filament LED 12W

□ ▽ IP20 CE





# VOL

Table lamp / Lámpara de sobremesa

The VOL table lamp has a simple combination of lines and volumes, which create a geometric sculptural form, while being optimal in its shape for lighting spaces.

It has a conical shade, a structure that combines metal with natural wood, and a four-arm base.

La lámpara de sobremesa VOL presenta una sencilla combinación de líneas y volúmenes, que crean una forma escultórica geométrica, a la vez que óptima en su forma para iluminar espacios.

Tiene una pantalla cónica, una estructura que combina metal con madera natural y una base de cuatro pies.



L0934



Option in fabric / Opción en tela

L0935



Option in rattan / Opción en ratán

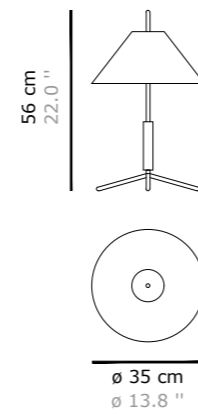

[Watch video of the Vol table white-fabric / Ver vídeo Vol sobremesa blanco-tela.](#)

## MATERIALES Y ACABADOS / MATERIALS & FINISHES

Ref. / Ref.	Structure / Estructura	Lampshade / Pantalla	Cable / Cable
L0934	White metal and beech wood / Metal blanco y madera de haya	White fabric / Tela blanca	Textile / Textil
L0935	White metal and beech wood / Metal blanco y madera de haya	Natural rattan / Ratán natural	Textile / Textil

## RECOMMENDED LIGHT SOURCE / FUENTE DE LUZ RECOMENDADA

L0934: 2 x E-27 LED 12W

L0935: 2 x E-27 filament LED 12W

IP20 CE





# VOL

Table lamp / Lámpara de sobremesa

The VOL table lamp has a simple combination of lines and volumes, which create a geometric sculptural form, while being optimal in its shape for lighting spaces.

It has a conical shade, a structure that combines metal with natural wood, and a four-arm base.

La lámpara de sobremesa VOL presenta una sencilla combinación de líneas y volúmenes, que crean una forma escultórica geométrica, a la vez que óptima en su forma para iluminar espacios.

Tiene una pantalla cónica, una estructura que combina metal con madera natural y una base de cuatro pies.

L0933

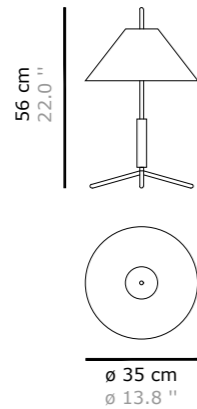

Option in fabric / Opción en tela



Watch video of the Vol table black-fabric /  
Ver vídeo Vol sobremesa negro-tela.

## MATERIALES Y ACABADOS / MATERIALS & FINISHES

Ref. / Ref.	Structure / Estructura	Lampshade / Pantalla	Cable / Cable
L0933	Black metal and beech wood / Metal negro y madera de haya	Black fabric / Tela negra	Textile / Textil

## RECOMMENDED LIGHT SOURCE / FUENTE DE LUZ RECOMENDADA

L0933: 2 x E-27 LED 12W





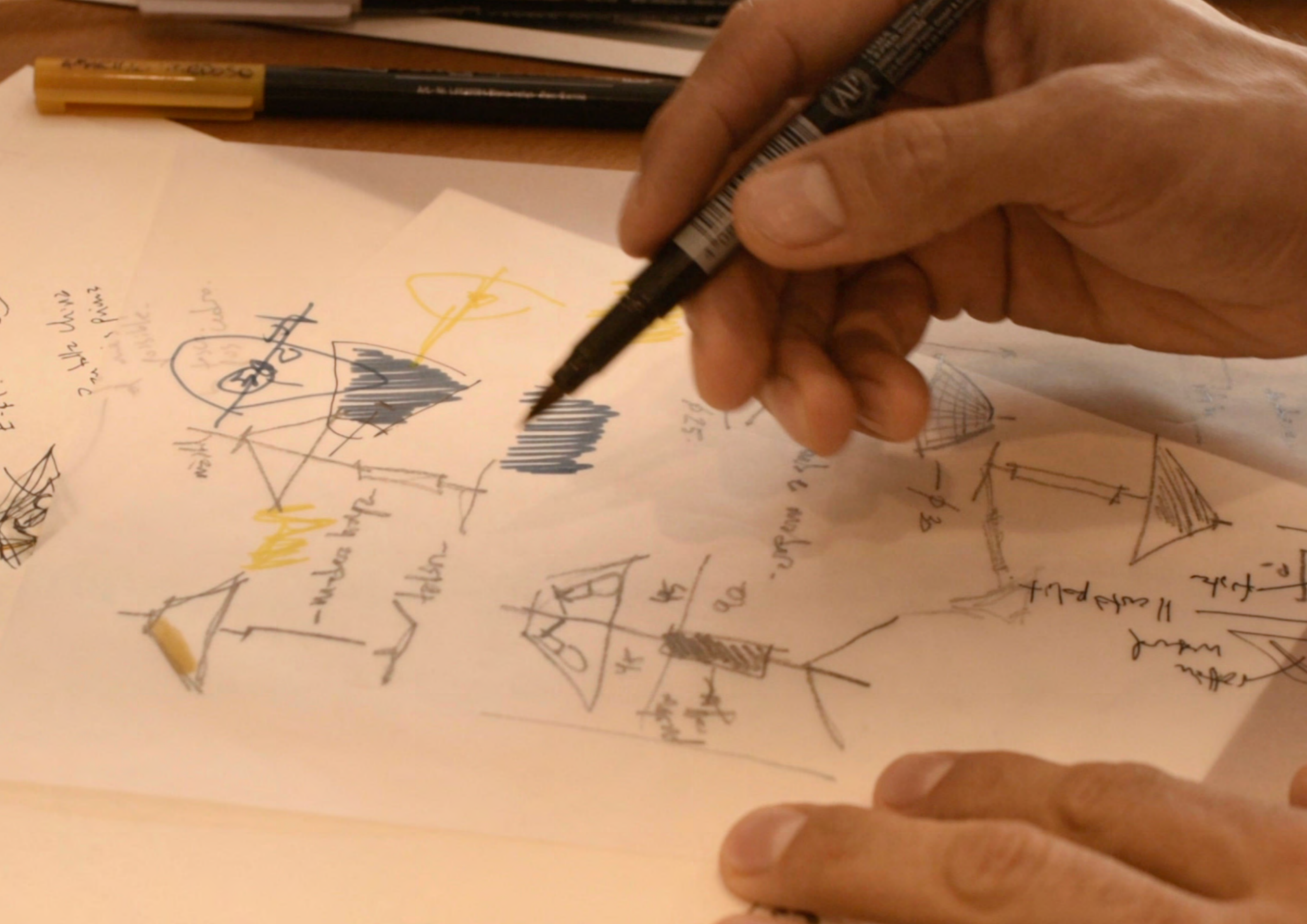

Can the units  
be printed  
possible.

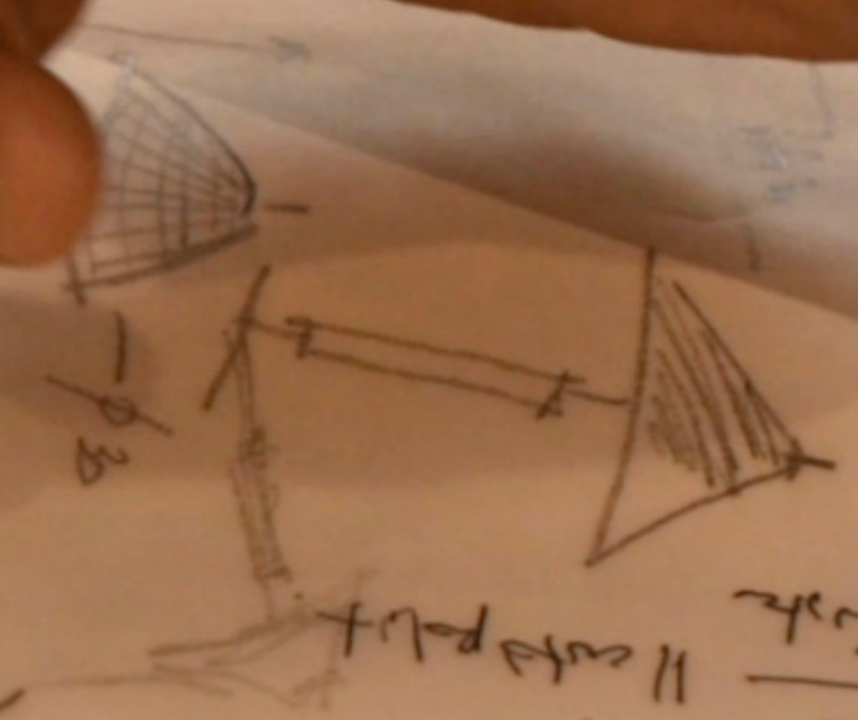
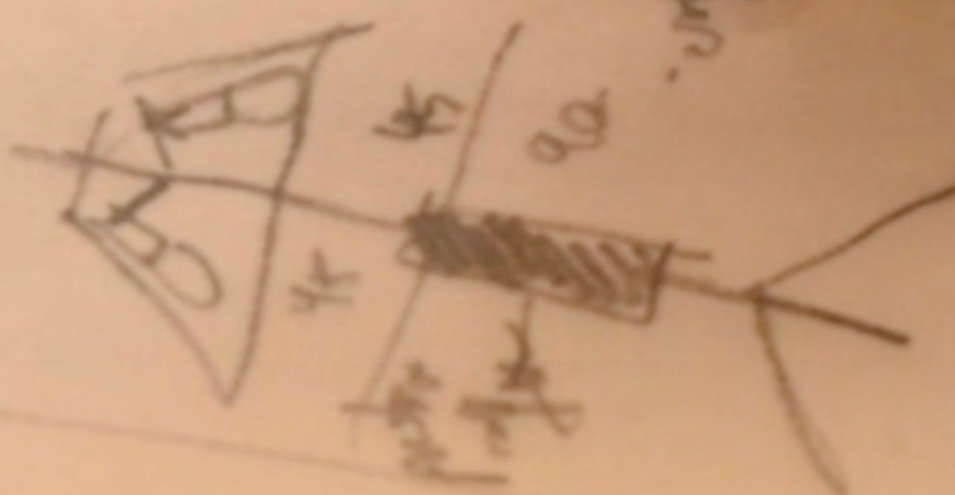

cut & paste  
p-10  
p-15  
p-20  
p-25  
p-30  
p-35  
p-40  
p-45  
p-50  
p-55  
p-60  
p-65  
p-70  
p-75  
p-80  
p-85  
p-90  
p-95  
p-100





[MTOBJECTS.COM](http://MTOBJECTS.COM)



PHOTOGRAPHY / FOTOGRAFIA Laura Piqué Marquez

Mediterranean Objects se reserva el derecho a efectuar modificaciones en las características técnicas y acabados de los productos que se muestran en este catálogo.  
Mediterranean Objects reserve the right to carry out any modification to the technical features and finish of the products displayed in the catalogue without prior notice.



## MEDITERRNEAN OBJECTS

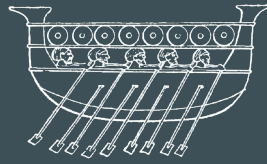

Barcelona, Spain

@mediterraneanobjects



[www.mtobjects.com](http://www.mtobjects.com)